



KRONOTEX

BY SWISS KRONO GROUP



EN

Made in 
Germany

FLOORS FOR LIVING

2018

OUR ENVIRONMENTAL PRODUCT DECLARATION

In order for environmental product balance sheets to be meaningful, they must be objectively comparable. So to let our customers easily understand and contrast our lifecycle analyses and environmental product data with those of other materials, we have firmly committed ourselves to a policy of total product transparency. We openly and voluntarily communicate the ecological balance sheets of our wood-based products in our Environmental Product Declarations (EPDs). Each EPD is issued by the Institute Construction and Environment e.V. (IBU) in a format which was developed on the basis of internationally valid ISO standards in close collaboration with building and environmental authorities in Germany.

WE STAND FOR ECOLOGY

The only way to master major challenges is for all players to pull on one rope. One of the biggest and most urgent tasks facing humanity today is to protect the environment. ‘Together we are strong!’ – this statement also applies to achieving the sustainability goals we have set ourselves. All of our staff are involved in protecting the environment on a day-to-day basis. Each and every one of them is appropriately informed, instructed and trained. This ensures that every department has the environmental expertise it requires.

We use our ‘management for the earth’ programme to raise the level of environmental awareness in the entire SWISS KRONO team. Our environmental management efforts focus on achieving the eco-efficiency defined in our corporate objectives. Every product that leaves our factory must exhibit both excellent price/performance and superb environmental compatibility. This starts with the exclusive use of legal, certified raw materials from sustainably managed forests, continues with rigorously monitored production, and is also ensured during subsequent utilisation and ultimate disposal of our products.

WE HAVE BIG PLANS

our unique blue planet tomorrow as well. We are therefore continuing to develop eco-friendly wood-based materials which are healthy for you and the environment alike. Right now we are preparing EPDs for all of our Kronotex laminate floorings to facilitate direct comparison and checking of their environmental benefits.

Has our environmental commitment piqued your curiosity? We’ll be happy to answer your questions. Simply e-mail us at sales.floor@swisskrono.de



Our Environmental Product Declarations (EPDs) are globally acknowledged and accepted Type III environmental labels conforming to ISO 14025.







WE'RE PASSIONATE ABOUT WOOD

SWISS KRONO – A STRONG BRAND FAMILY

As a Swiss family company, we develop design solutions for sophisticated living spaces made from natural raw materials – in more than 121 countries, with expertise born from years of experience and outstanding interior and exterior results.



PARTNERSHIP

We work together with you to develop first-class solutions that truly suit your needs. We are always at your side, even after the end of a project. Your trust is what drives us.



MADE IN GERMANY

All of our products are designed, manufactured and certified in Germany. This outstanding quality reflects the high demands we place on ourselves every day in order to provide you with the best possible solution.



RESPONSIBILITY

We are dedicated to a high level of resource efficiency and renewable energy. Our strategy: complete usage of material flows, short distances, renewable energy sources and a high level of energy efficiency.



➤ Further information can be found on [swisskrono.com](https://www.swisskrono.com)



A floor is the foundation for every type of room design, and hence the basis for creating one's own sense of what life should be all about. For this purpose, Kronotex opens up a completely new world for you. Experience laminate floors which meet all demands, which feature unique aesthetics and top-class quality. There is no limit to where your imagination can carry you!

Structures	06
Surfaces	08
Characteristics / Individual features	09
Product overview	10
MAMMUT PLUS AC 5 10 mm	12
MAMMUT AC 5 12 mm	18
ROBUSTO AC 5 12 mm	24
AMAZONE AC 5 10 mm	30
EXQUISIT PLUS AC 4 8 mm	34
EXQUISIT AC 4 8 mm	40
GLAMOUR AC 4 8 mm	46
MEGA PLUS AC 4 8 mm	54
DYNAMIC PLUS AC 4 8 mm	58
DYNAMIC AC 4 8 mm	62
The CLIC-System	68
Installation instructions on YouTube	69
Technical information	70
Accessories	72
Online Floor Studio	78
Quality on principle	79

Made in  Germany

STRUCTURES

PR / Wood Pore

typical wood structure

MO / Matt Oiled

matt oiled surface appearance

WG / Wood Grain

rustic embossing

MX / Matrix

deep structure embossing with
typical wood matt/gloss contrast

ST / Stone

distinctive stone

ER / Registered Emboss

genuine wood appearance due to
consistence between pattern and
embossing

HG / High Gloss

high gloss surface hardened with
electron beam

CP/ER / Chrome Pore

wood structure with shine effect

AF / Authentic Floor

natural and vivid wood texture

UL / Used Look

with apparently signs of wear and tear

Matt Finish

electron beam-hardened matt surface

Matt Look

With a waxed look & feel

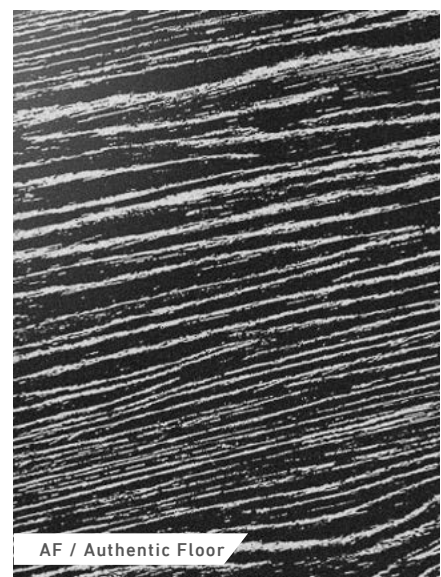
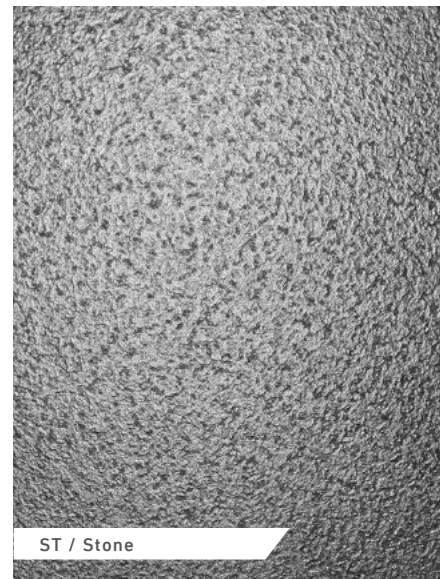

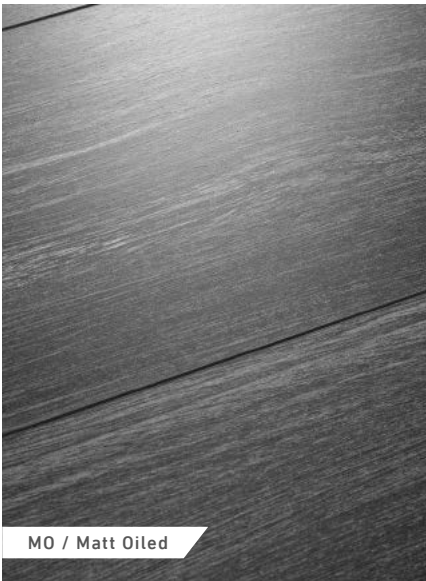

MO / Matt Oiled



WG / Wood Grain



MX / Matrix

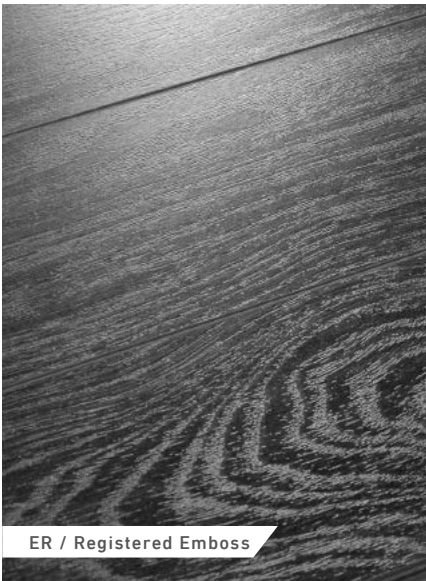

ER / Registered Emboss



HG / High Gloss

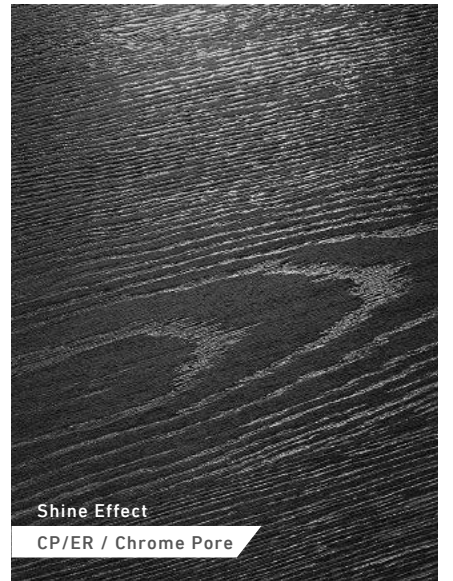

Shine Effect
CP/ER / Chrome Pore

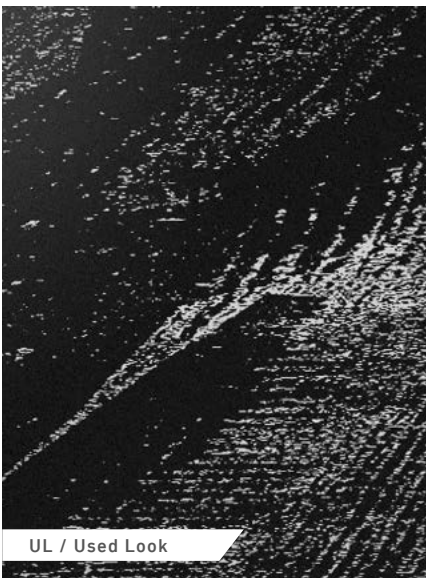

UL / Used Look

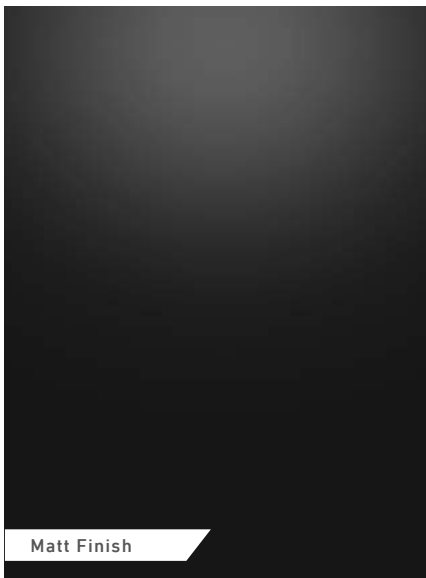

Matt Finish



Matt Look

SURFACES



1-Strip

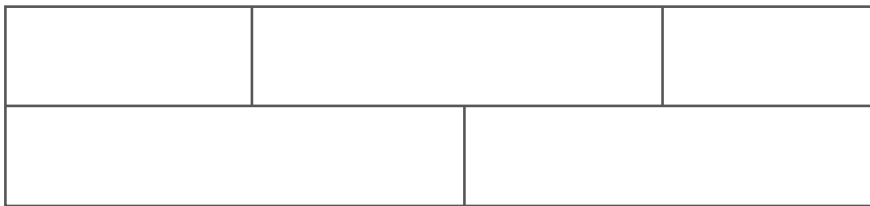

2-Strip

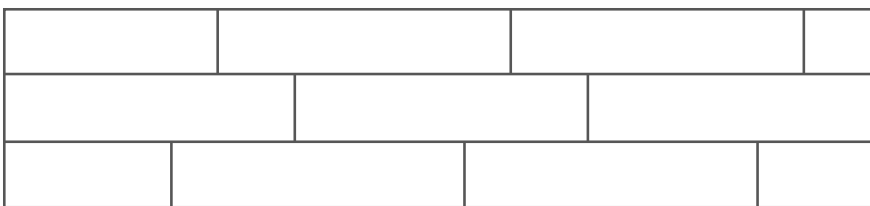

3-Strip

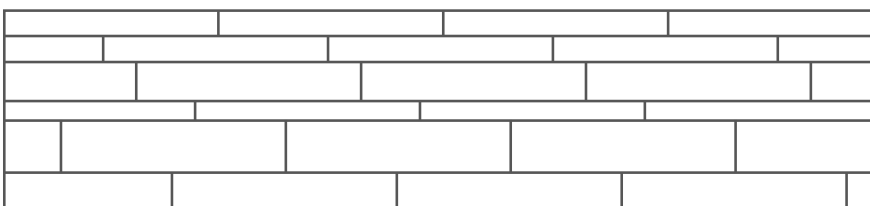

Multi-Strip

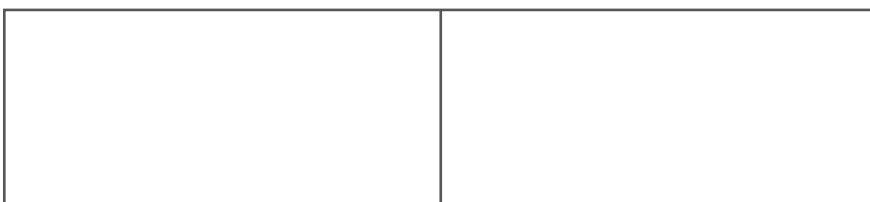

Natural stone format XL



Natural stone format

CHARACTERISTICS



Kronotex floors are low-maintenance and hard-wearing.



Kronotex floors are flame resistant.

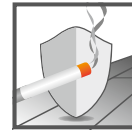

Kronotex floors are largely resistant to cigarette burns.



Kronotex floors are non-fading and retain their brilliance over many years.



Kronotex floors are rugged, load and impact-resistant.



Kronotex floors are abrasion-resistant.



Kronotex floors are produced from natural sustainable raw materials.



Kronotex floors are comfortable underfoot.

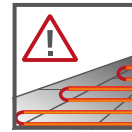

Kronotex floors are well suited for installation over sub-floor heating.



Kronotex floors are stain-resistant.



Kronotex floors are virtually scratchproof.

INDIVIDUAL FEATURES

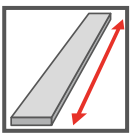

These panels are especially long.

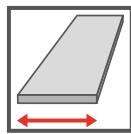

These panels are especially wide.

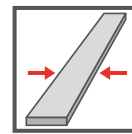

These panels are especially narrow.



These panels have a special surface structure.



High gloss surface



Antistatic

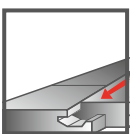

Fast installment thanks to an easy-to-use angle-angle locking system for the long and short sides of the boards.



These panels feature a 45° sloped edge. When they are joined together, a V-groove forms, producing a natural solid wood character. V4 - all the way round



A 5G snap-together system makes the flooring even easier to install.

KRONOTEX PRODUCT OVERVIEW

MAMMUT PLUS

PANEEL 1845 x 244 x 10 mm

BOX 4 panels | 1,800 m²

PALLET 42 boxes | 75,600 m²



AC 5
COMMERCIAL 33

MAMMUT

PANEL 1845 x 188 x 12 mm

BOX 4 panels | 1,387 m²

PALLET 56 boxes | 77,697 m²



AC 5
COMMERCIAL 33

ROBUSTO

PANEL 1375 x 188 x 12 mm

BOX 5 panels | 1,293 m²

PALLET 56 boxes | 72,380 m²



AC 5
COMMERCIAL 33

AMAZONE

PANEL 1380 x 157 x 10 mm

BOX 6 panels | 1,300 m²

PALLET 40 boxes | 52,000 m²



AC 5
COMMERCIAL 33

EXQUISIT PLUS

PANEL 1380 x 244 x 8 mm

BOX 8 panels | 2,694 m²

PALLET 42 boxes | 113,138 m²



AC 4
COMMERCIAL 32

EXQUISIT

PANEL 1380 x 193 x 8 mm

BOX 8 panels | 2,131 m²

PALLET 56 boxes | 119,320 m²

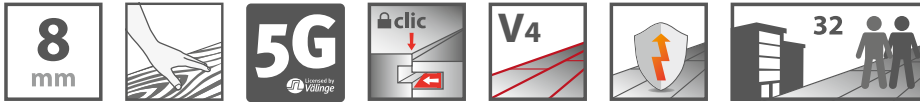

AC 4
COMMERCIAL 32

GLAMOUR

PANEL 644 x 310 x 8 mm

BOX 10 panels | 1,996 m²

PALLET 42 boxes | 83,849 m²

PANEL 1380 x 193 x 8 mm

BOX 8 panels | 2,131 m²

PALLET 32 boxes | 68,192 m²

PANEL 1295 x 310 x 8 mm

BOX 6 panels | 2,409 m²

PALLET 36 boxes | 86,724 m²

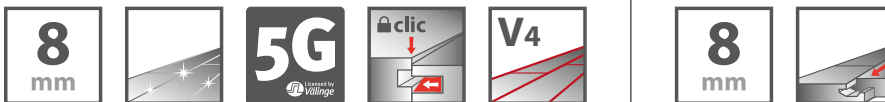

AC 4

MEGA PLUS

PANEL 1380 x 326 x 8 mm

BOX 5 panels | 2,249 m²

PALLET 45 boxes | 101,223 m²



AC 4
COMMERCIAL 32

DYNAMIC PLUS

PANEL 1380 x 193 x 8 mm

BOX 8 panels | 2,131 m²

PALLET 56 boxes | 119,320 m²



AC 4
COMMERCIAL 32

DYNAMIC

PANEL 1380 x 193 x 8 mm

BOX 8 panels | 2,131 m²

PALLET 56 boxes | 119,320 m²



AC 4
COMMERCIAL 32



MAMMUT PLUS

kronotex.com

D3670 Makro Oak Light Grey





MAMMUT PLUS

The best and more. This is the promise of the new decors of the MAMMUT PLUS collection from Kronotex. While exhibiting the same technical mastery as all MAMMUT flooring, this new line offers you even more authenticity, an even larger choice of styles and even greater perfection. Apart from its incredible robustness and versatility, MAMMUT PLUS also raises the bar in other ways. Its extra-wide panels complement the existing extra-long and extra-sturdy versions of the MAMMUT family. And the decors seduce you with their elegantly authentic natural wood look, which can't help but add posh country-style comfort to your home.

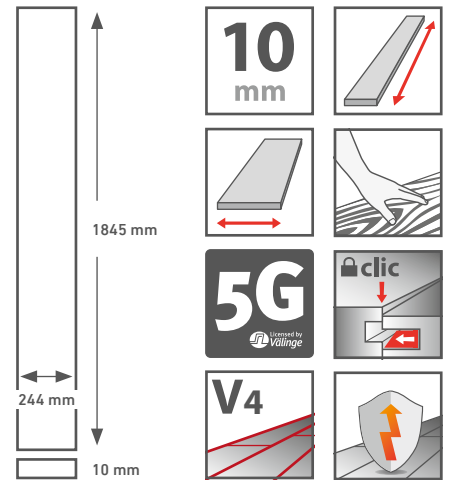

USE CLASS 33 | AC 5

BOX 4 panels | 1,800 m²

PALLET 42 boxes | 75,600 m²

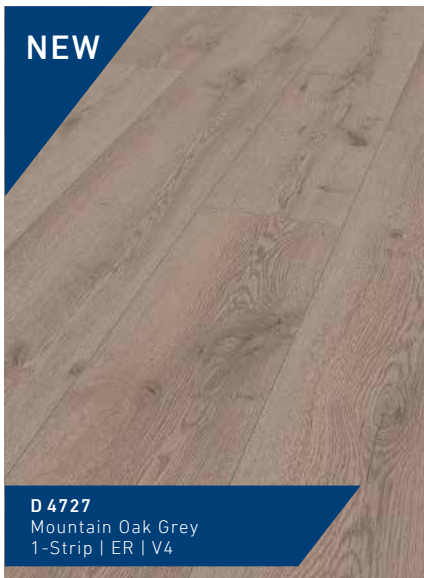
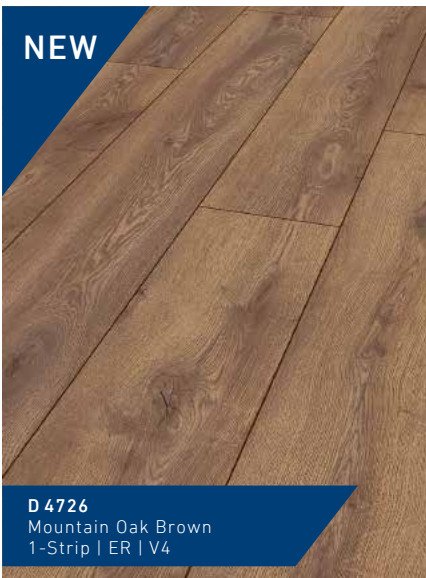

MAMMUT PLUS

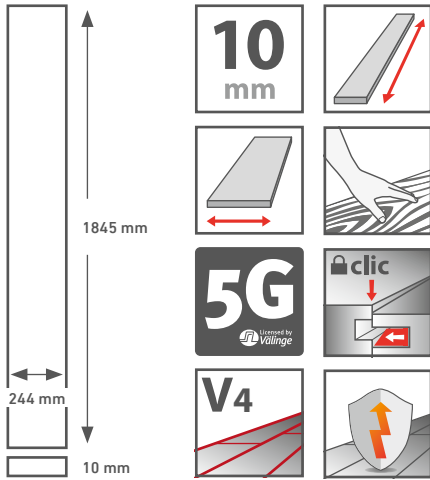

USE CLASS 33 | AC5

BOX 4 panels | 1,800m²

PALLET 42 boxes | 75,600m²





D 4797
Highland Oak Silver
1-Strip | ER | V4



D 4798
Highland Oak Black
1-Strip | ER | V4



D 3670 Makro Oak Light Grey



MAMMUT

kronotex.com

D4752 Makro Oak Light



MAMMUT

For many, the best is just about good enough. And if you are always striving towards perfection as well, then there is only one floor for you: MAMMUT from Kronotex. It combines the best features of ROBUSTO, DYNAMIC and EXQUISIT, and is thus the absolute Nonplus-Ultra of laminate floors. Whether used universally, for extremely heavy loads or to create a sophisticated and natural look, MAMMUT is a floor which can meet all requirements. The panels are extra hard, extra long and, what's more, extra practical. An outstanding feature of the patterns and hues is their country cottage character and the fascinating, authentic natural wood look.

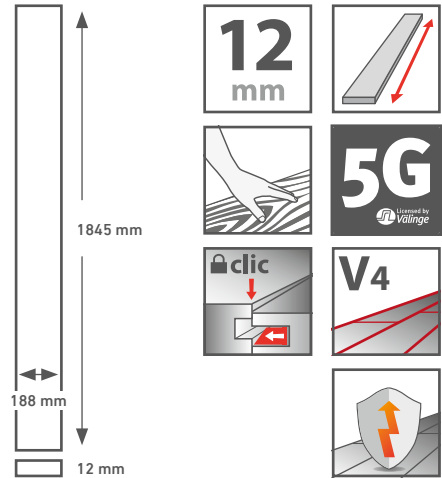

USE CLASS 33 | AC 5

BOX 4 panels | 1,387 m²

PALLET 56 boxes | 77,697 m²



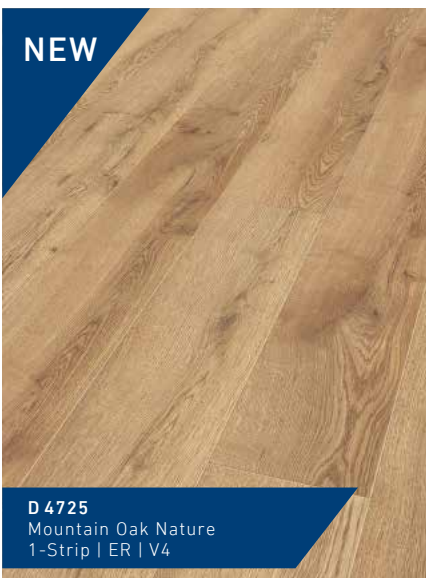

MAMMUT

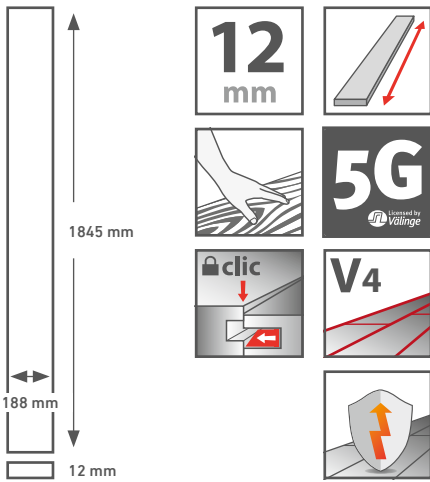

USE CLASS 33 | AC 5
 BOX 4 panels | 1,387 m²
 PALLET 56 boxes | 77,697 m²





D 4797
Highland Oak Silver
1-Strip | ER | V4

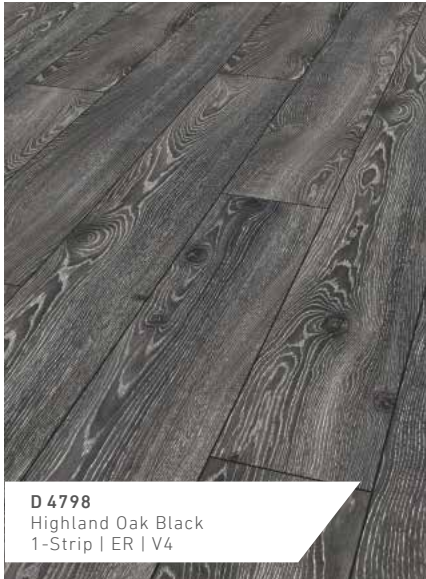

D 4798
Highland Oak Black
1-Strip | ER | V4

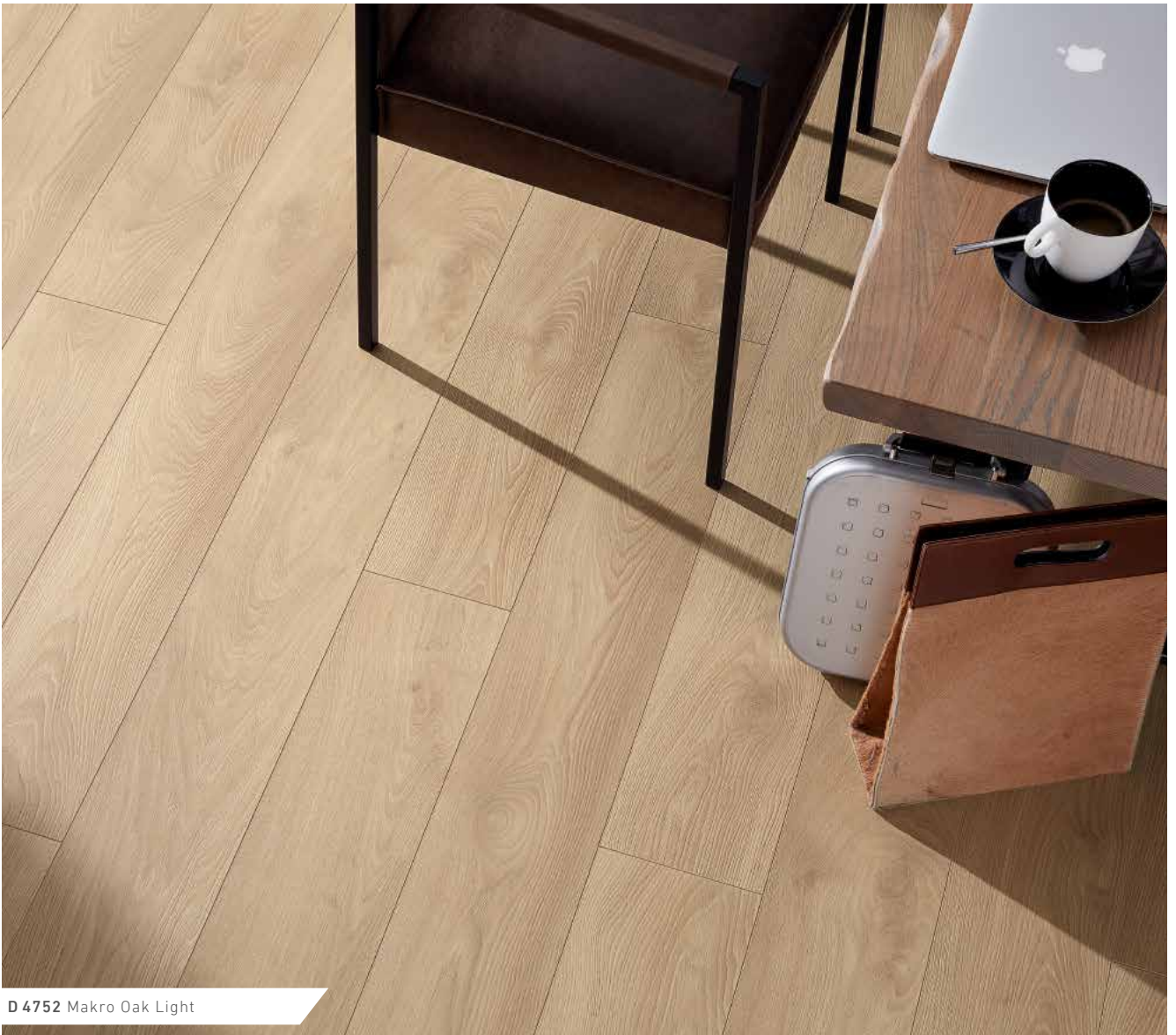

D 4752 Makro Oak Light



ROBUSTO

kronotex.com

D4779 Fantasy Wood





ROBUSTO

There are situations in life where one needs a thick skin. Where one has to be very resilient and tough. Which is why ROBUSTO is also the perfect floor for extreme levels of use. With its high-density, 12-mm thick fibreboard and an especially wear-resistant surface, it can cope with pretty much anything to which it is exposed. Even if used for commercial purposes. Its CLIC tongue-and-groove connection system will never disappoint in any situation as it was specially developed to hold up under the highest pressure.

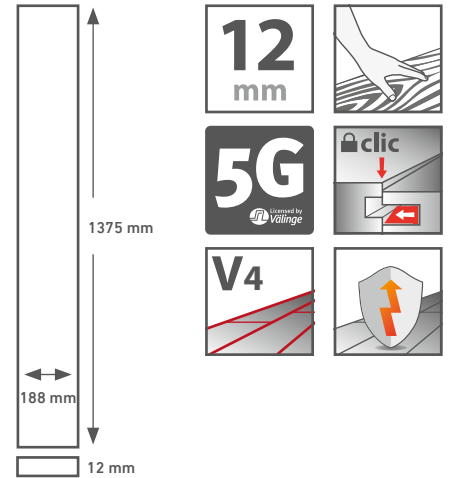

USE CLASS 33 | AC 5

BOX 5 panels | 1,293 m²

PALLET 56 boxes | 72,380 m²



ROBUSTO

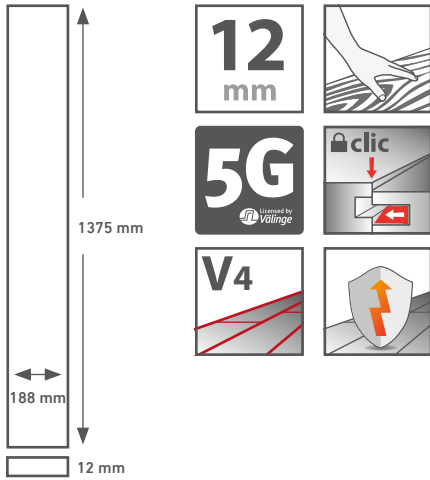

USE CLASS 33 | AC 5

BOX 5 panels | 1,293 m²

PALLET 56 boxes | 72,380 m²







AMAZONE

kronotex.com

D3668 Oak Dezent



AMAZONE

Be graceful. Prove style. With AMAZONE, the floor for everyone who appreciates the exclusive and the extraordinary. It combines conventional beauty with individual fashioning opportunities, and thus lends that special something to every setting. AMAZONE floorings are narrow and long, which creates a particularly graceful look. This also helps create the most fascinating of patterns. Whether you are aiming at a systematic, individual or absolutely noble look, this floor can be fashioned to meet all your ideas with its sophisticated patterns and hues.

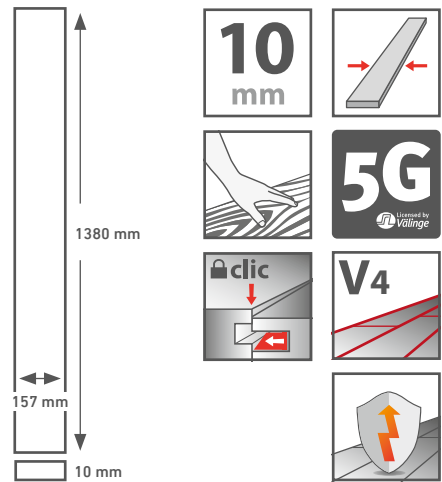

USE CLASS 33 | AC 5

BOX 6 panels | 1,300 m²

PALLET 40 boxes | 52,000 m²





D 4166
Prestige Oak Nature
1-Strip | ER | V4



D 4167
Prestige Oak Grey
1-Strip | ER | V4



D 4169
Prestige Oak Light
1-Strip | ER | V4

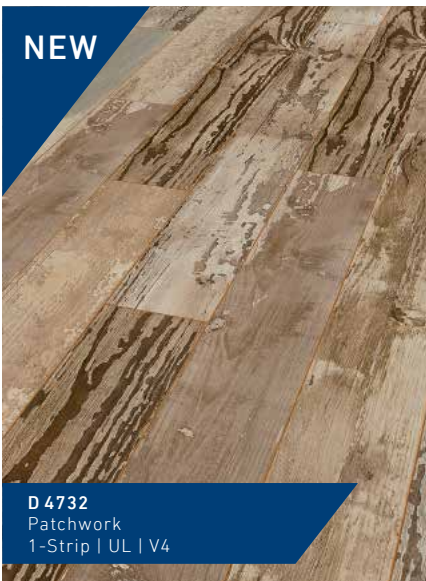

D 4732
Patchwork
1-Strip | UL | V4



D 4754
Oak Hella
1-Strip | UL | V4



D 4766
Pettersson Oak Dark
1-Strip | ER | V4



EXQUISIT PLUS

kronotex.com

D4766 Pettersson Oak Dark





EXQUISIT PLUS

This brand's decors feature a wide range of carefully selected, exquisite natural wood styles. Their sublime, evenly embossed, subtly gleaming surfaces and virtually nature-identical grain drive home this collection's perfection and exceptional quality. The extra-wide panels invite you to create elegant, spacious rooms with a very special, warm feel-good ambiance. The precisely milled V-grooves are the finishing touch to this attractive, real-looking plank floor.

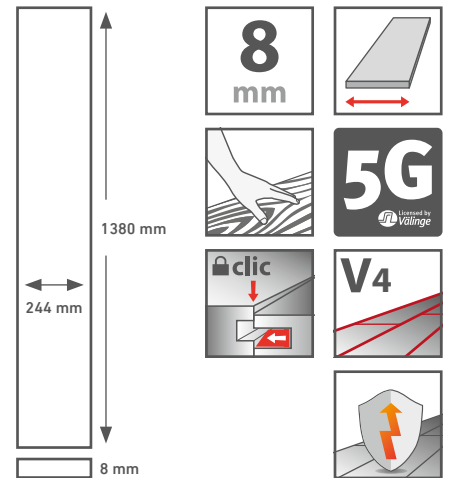

USE CLASS 32 | AC4

BOX 8 panels | 2,694 m²

PALLET 42 boxes | 113,138 m²



EXQUISIT PLUS

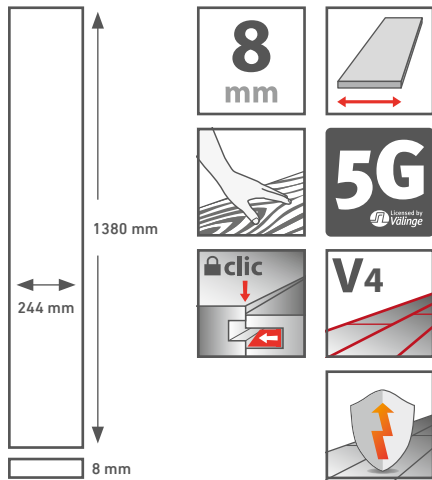

USE CLASS 32 | AC 4

BOX 8 panels | 2,694 m²

PALLET 42 boxes | 113,138 m²



D 3663
Montmelo Oak Lava
1-Strip | ER | V4



D 3664
Montmelo Oak Toffee
1-Strip | ER | V4



D 3673
Bergamo Oak
1-Strip | AF | V4



D 4164
Village Oak
1-Strip | MX | V4



D 4708
Visby
1-Strip | UL | V4



D 4710
Walnut Mataro
1-Strip | ER | V4



D 4715
Chestnut Bordeaux
1-Strip | ER | V4



D 4716
Chestnut Pinot
1-Strip | ER | V4



D 4764
Petterson Oak Nature
1-Strip | ER | V4



D 4766
Petterson Oak Dark
1-Strip | ER | V4



D 4767
Palace Oak Dark
2-Strip | AF | V4



D 4780
Grivola
Multi-Strip | UL | V4



D 4783
Gala Oak Nature
1-Strip | ER | V4



D 4784
Gala Oak Brown
1-Strip | ER | V4



D 4785
Gala Oak Titan
1-Strip | ER | V4



D 4787
Gala Oak White
1-Strip | ER | V4



EXQUISIT

kronotex.com

D3665 Rosemont Oak



EXQUISIT

EXQUISIT is a floor which is as noble and natural as wood. It is perfection itself, radiates warmth and comfort and is as pleasant to walk upon as solid wood. Its synchronised, embossed grain and the matt surface shimmer give it an authentic structure and create a warm, natural atmosphere. And the carefully milled V-groove also contributes to the typical, representative floor-board look.

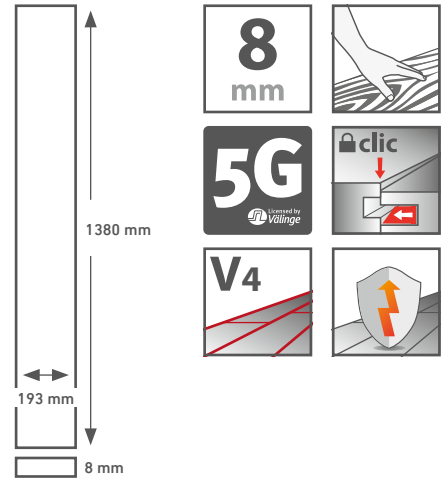

USE CLASS 32 | AC 4

BOX 8 panels | 2,131 m²

PALLET 56 boxes | 119,320 m²

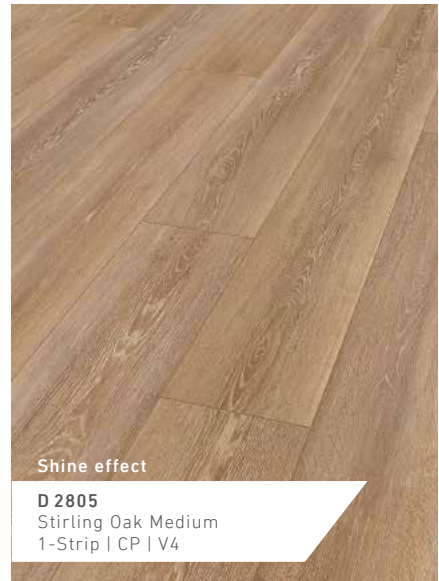



D 2987
Whitewashed Oak
1-Strip | MX | V4



D 3004
Waveless Oak Nature
1-Strip | ER | V4



D 3070
Tuscany Walnut
1-Strip | ER | V4



D 3223
Atlas Oak White
1-Strip | ER | V4



D 3224
Atlas Oak Natur
1-Strip | ER | V4



D 3241
Nostalgie Teak Beige
1-Strip | ER | V4



D 3242
Nostalgie Teak Silver
1-Strip | ER | V4



D 3665
Rosemont Oak
Multi-Strip | AF | V4



D 3672
Turin Oak
1-Strip | AF | V4

EXQUISIT

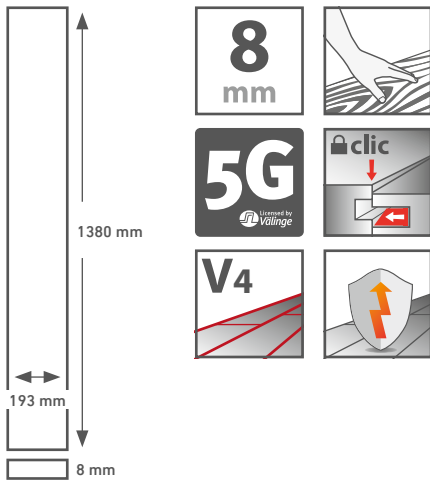

USE CLASS 32 | AC 4

BOX 8 panels | 2,131 m²

PALLET 56 boxes | 119,320 m²



D 4166
Prestige Oak Nature
1-Strip | ER | V4



D 4168
Prestige Oak Dark
1-Strip | ER | V4



D 4169
Prestige Oak Light
1-Strip | ER | V4



D 4170
Nostalgie Teak
1-Strip | ER | V4



D 4171
Nostalgie Teak Graphit
1-Strip | ER | V4

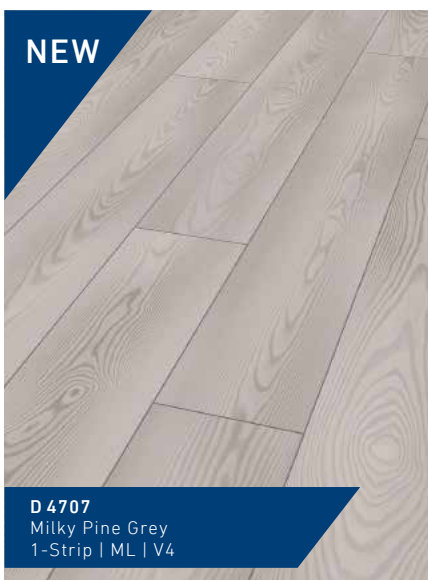

D 4707
Milky Pine Grey
1-Strip | ML | V4



D 4754
Oak Hella
1-Strip | UL | V4



D 4760
Alto
1-Strip | AF | V4



D 4763
Pettersson Oak Beige
1-Strip | ER | V4



D 4765
Pettersson Oak Grey
1-Strip | ER | V4



D 4782
Brave
1-Strip | UL | V4



D 4786
Gala Oak Grey
1-Strip | ER | V4



D 4790
Oak Liskamm
1-Strip | UL | V4



GLAMOUR

kronotex.com

Q 004 Palazzo



GLAMOUR

A floor unlike any you have ever seen before – one which only Kronotex can create with such luxury and fascination. A highly-elegant look, a compelling effect, a sophisticated design. GLAMOUR cannot fail to impress with its sophisticated, highly exclusive look as well as with its typical Kronotex usage properties. But this is only to be expected! This floor has been coated with several layers of extremely hard wearing lacquer and designed for a wide variety of uses. And it offers all the guarantees for demanding usage with a high level of comfort and universal safety.

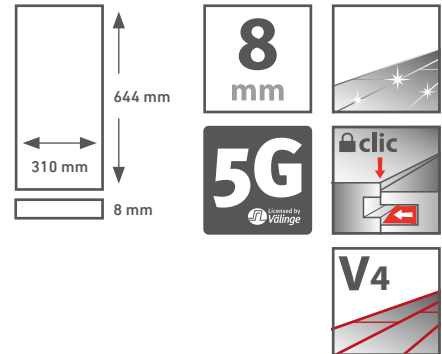

ABRASION CLASS AC 4

BOX 10 panels | 1,996 m²

PALLET 42 boxes | 83,849 m²



D 2909
Botticino Classico Dark
Natural stone format | HG | V4



D 2911
Botticino Classico Light
Natural stone format | HG | V4



D 2921
Carrara Marmor
Natural stone format | HG | V4

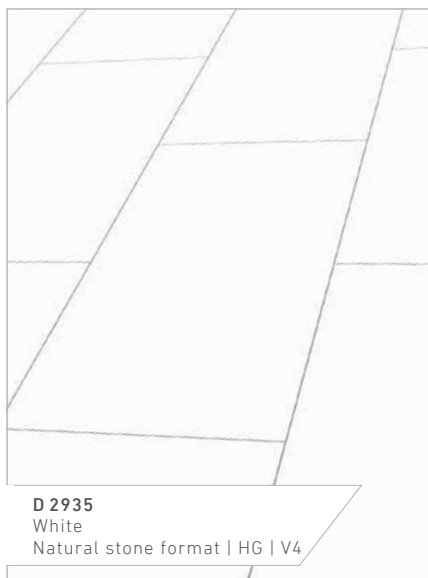

D 2935
White
Natural stone format | HG | V4



D 3527
Pindos
Natural stone format | HG | V4



D 3528
Solino
Natural stone format | HG | V4



D 3547
Loft
Natural stone format | HG | V4



D 4178
Monreal Slate
Natural stone format | HG | V4



D 4179
Grizzly Slate
Natural stone format | HG | V4



D 8434
Piasentina
Natural stone format | HG | V4

GLAMOUR

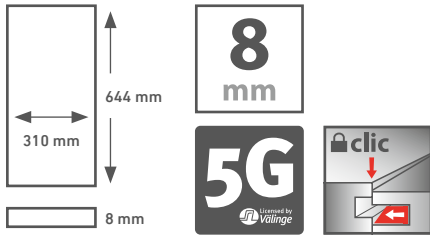

ABRASION CLASS AC 4

BOX 10 panels | 1,996 m²

PALLET 42 boxes | 83,849 m²

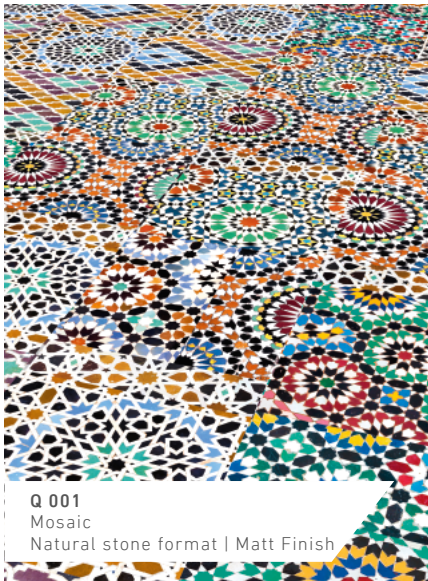

Q 001
Mosaic
Natural stone format | Matt Finish

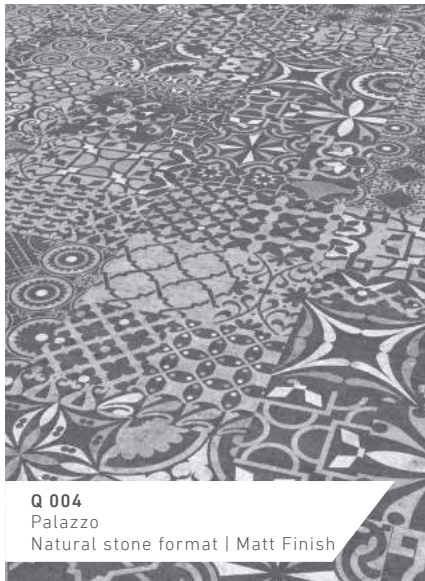

Q 004
Palazzo
Natural stone format | Matt Finish

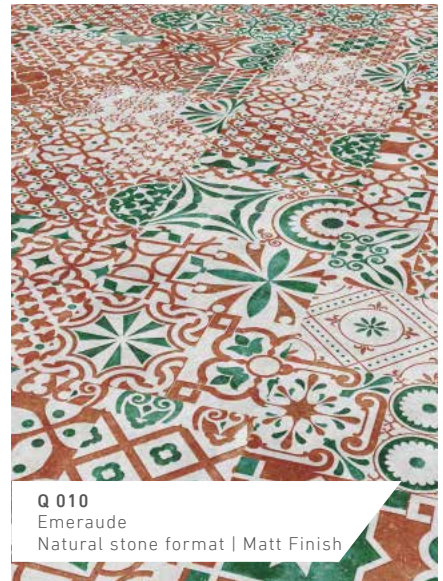

Q 010
Emeraude
Natural stone format | Matt Finish

GLAMOUR

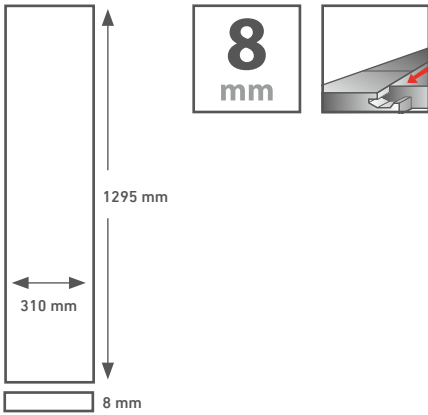

ABRASION CLASS AC4

BOX 6 panels | 2,409 m²

PALLET 36 boxes | 86,724 m²

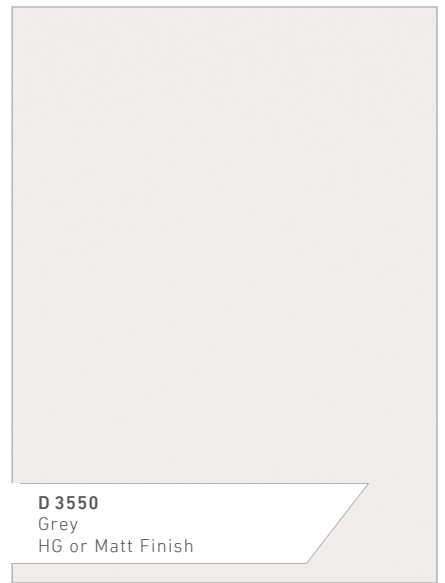
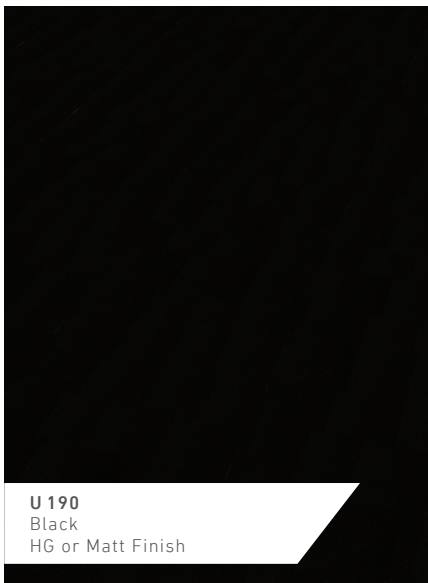

GLAMOUR

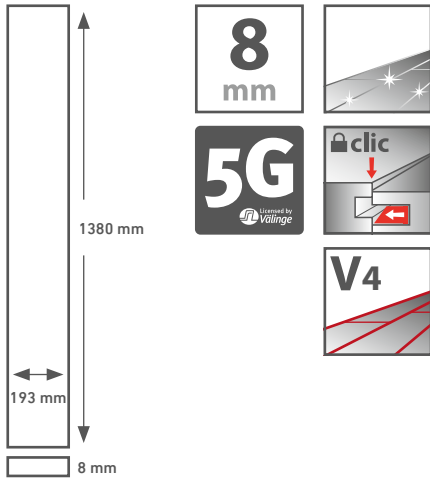

ABRASION CLASS AC 4
BOX 8 panels | 2,131 m²
PALLET 32 boxes | 68,192 m²





D 4187
White Oak
1-Strip | HG | V4



D 4188
Morris Walnut
1-Strip | HG | V4



D 4189
Victorian Oak
1-Strip | HG | V4

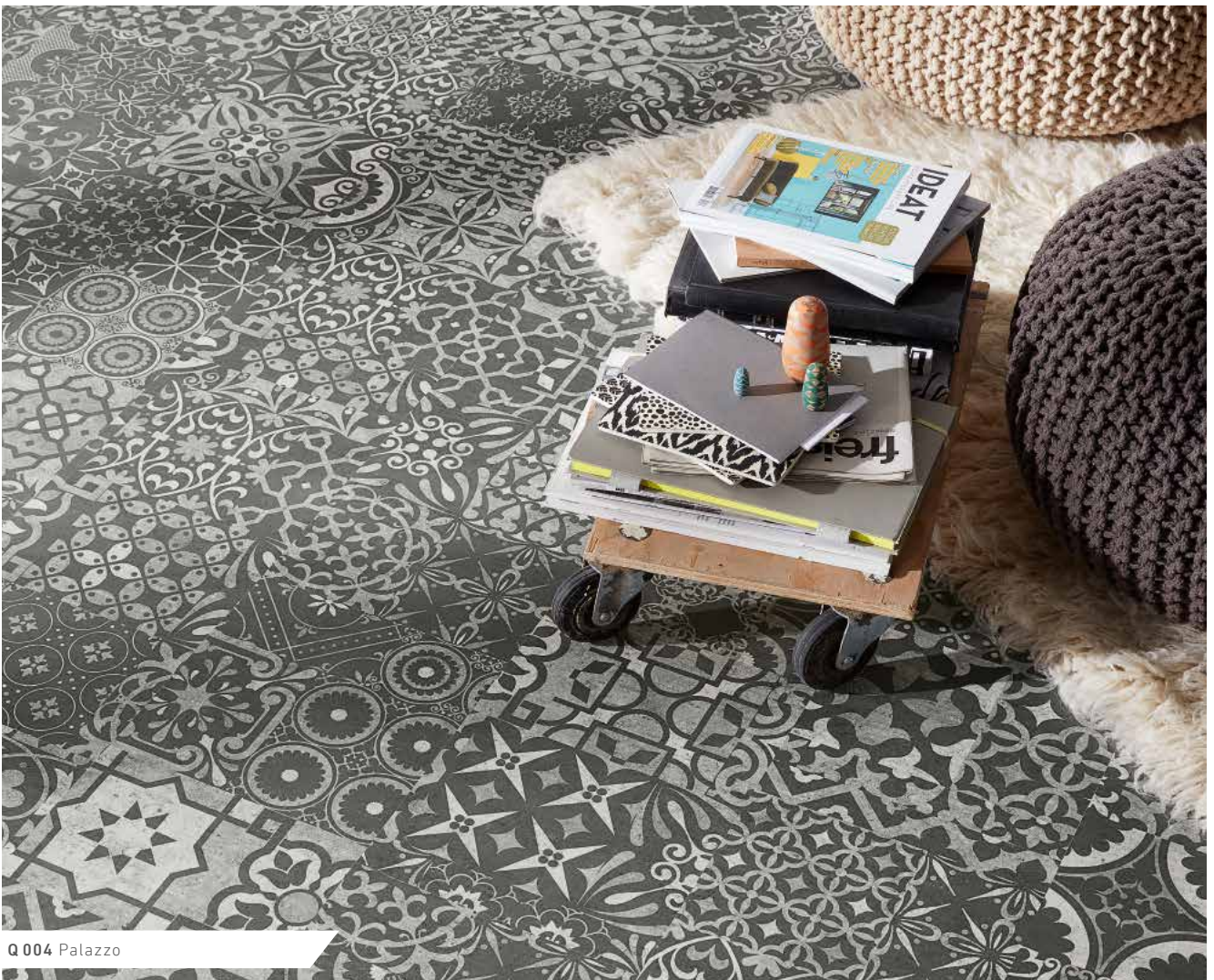

Q 004 Palazzo



MEGA PLUS

kronotex.com

D 3668 Oak Dezent | D 3000 Naxos



MEGA PLUS

Sublime in every respect: the laminate floors of the MEGA PLUS collection generously accentuate the stylish ambience of any room, making a strong and harmonious impression with their widely ranging decors in extra-wide format. MEGA PLUS floors astonish with their fresh wood and classic stone tile-look decors. The timelessly attractive tile decors make rooms appear sleek and streamlined, almost minimalistic. And the wood decors exude warmth and naturalness, thus ideally complementing country house-style interior decorations. MEGA PLUS also scores points with its extra-large panels, which enable fast, budget-friendly installation.

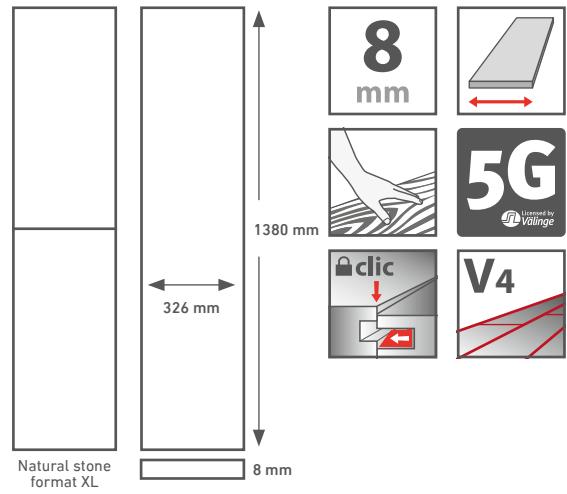

USE CLASS 32 | AC 4

BOX 5 panels | 2,249 m²

PALLET 45 boxes | 101,223 m²

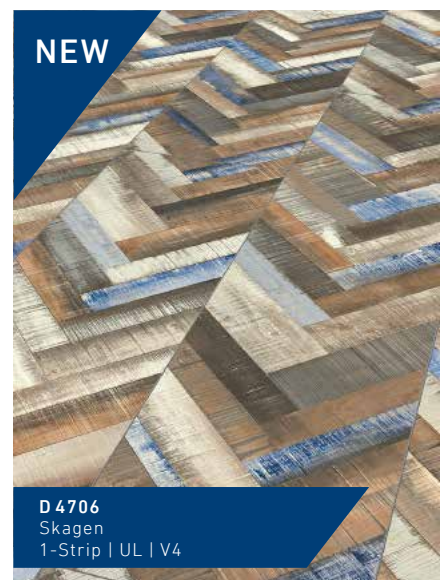





DYNAMIC PLUS

kronotex.com

D4771 Callisto



DYNAMIC PLUS

Floors have never before been this evocative and lively. DYNAMIC PLUS sparkles with an extra dose of passion and esprit. This line's fresh, versatile decors will surprise and inspire you at the same time. DYNAMIC PLUS allows you to fully express your individuality while letting your creativity run wild. Its astonishing versatility and strength make it the ideal all-rounder, also suitable for floors with heavy foot traffic. Without sacrificing either superb aesthetics or walking comfort.

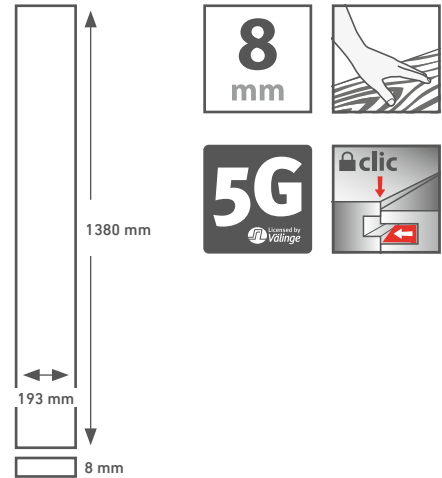

USE CLASS 32 | AC 4

BOX 8 panels | 2,131 m²

PALLET 56 boxes | 119,320 m²



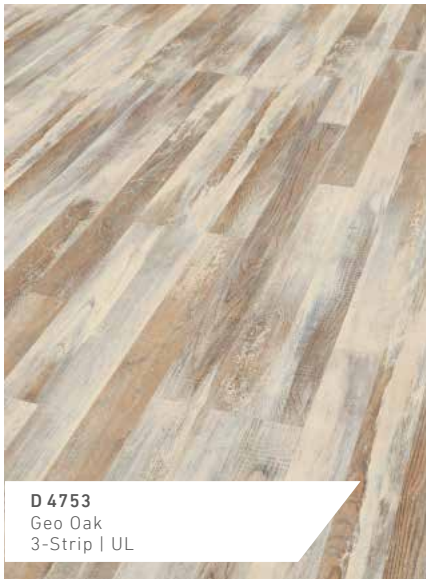



DYNAMIC

kronotex.com

D4757 Walnut Palazzo





DYNAMIC

DYNAMIC! A floor with which you can express your entire individuality. It can be used anywhere, is extremely resilient and, above all else, offers a unique variety of patterns and hues. All this makes DYNAMIC the perfect floor for your ideas. Develop your full potential and live your life as you want to live it. And if you want, your DYNAMIC floor can move around with you. It can be easily removed and re-installed somewhere else – even in medium used commercial areas.

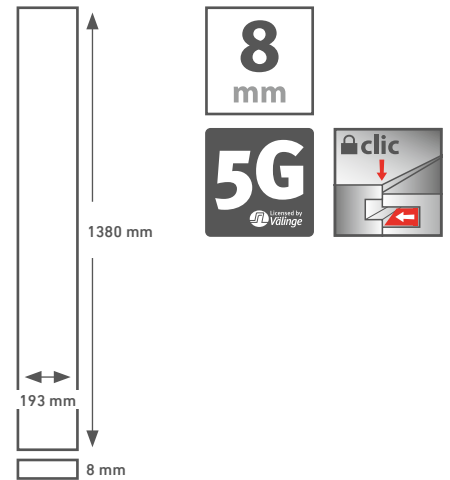

USE CLASS 32 | AC4

BOX 8 panels | 2,131 m²

PALLET 56 boxes | 119,320 m²



D 1407
Beech Royal
3-Strip | WG



D 2304
Oak Achat
3-Strip | MO



D 2450
Cutter Oak
2-Strip | MX



D 2929
Bourbon Oak
1-Strip | PR

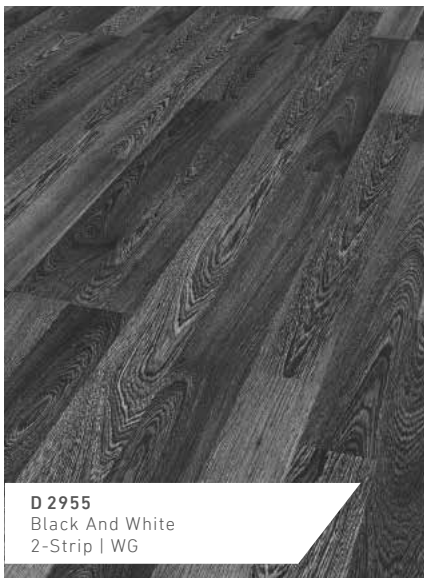

D 2955
Black And White
2-Strip | WG



D 2957
Hacienda Oak Beige
1-Strip | PR

DYNAMIC

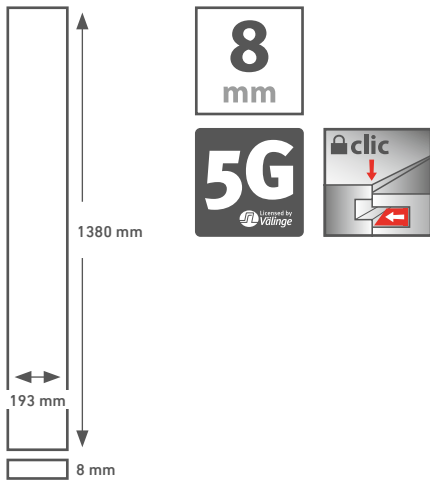

USE CLASS 32 | AC 4

BOX 8 panels | 2,131 m²

PALLET 56 boxes | 119,320 m²



D 2986
Borneo Teak
1-Strip | PR



D 3007
Stockholm Ash
2-Strip | MX



D 3066
Cloud Oak
3-Strip | M0



D 3585
Block Wood
1-Strip | M0

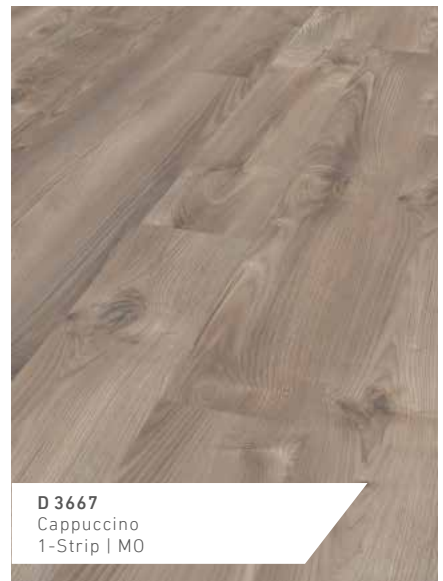

D 3667
Cappuccino
1-Strip | M0



D 4127
Nevada Pine
1-Strip | MX



D 4163
Bough Pine
1-Strip | MX



D 4751
Block Wood Nature
1-Strip | M0



D 4757
Walnut Palazzo
1-Strip | WG



D 4773
Walnut Historia
3-Strip | WG



D 4757 Walnut Palazzo

THE CLIC-SYSTEM



Installing a new floor is now playfully easy: simply press the panels down with a finger, and they snap audibly into place. Take them out of the box, insert, push down and you're done! The snap-together „Clic“ system is specially engineered to withstand peak loads. Also globally unique is the fact that Kronotex uses an optimised profile for each flooring thickness, which makes an especially big difference with 10 mm and 12 mm laminate. Professional installers and DIY enthusiasts alike greatly appreciate the advantages!



- Much easier to install.
- Up to 50% quicker to install.
- No hammer, tapping block and pulling bar required.
- Safe and stable.
- You can walk on the floor immediately after installation.

PANEL CONSTRUCTION

Kronotex laminates consist of at least four stable layers which ensure the extraordinary durability and unique quality of floors.

- A** The top surface of the flooring consists of a specially resistant protective overlay film. This is fused with an attractive resinated decorative film into a practically abrasion-proof, hardwearing surface.
- B** Extremely dense HDF fiberboard forms the supportive core (HDF, E1).
- C** On the undersurface of the core a dampnessimpeding stabilization film ensures and preserves the high structural stability of Kronotex laminates.



INSTALLATION INSTRUCTIONS ON YOUTUBE

DIY expert Thomas provides tips and tricks for laying laminate flooring in six easy steps.



Door frame and radiator pipes



Care and repair

Go to clips:
 YouTube-Channel
SWISS KRONO
 Heiligengrabe



Impact and room noise reduction



Transition strips and skirting boards



TECHNICAL INFORMATION

What counts is the right base

Once you have decided for a laminate floor, when quality and appearance are a perfect fit, then you need to check the requirements for perfect installation. Very important is a suitable subfloor:

- SWISS KRONO OSB
- old flooring such as wood, firmly-adhering PVC, dry ceramic, linoleum
- cement screed (max. residual moisture: 2.0 CM%)
- anhydrite cement and anhydrite flow cement screed (max. residual moisture: 0.3 CM%)
- magnesia screed (max. residual moisture: 3.0 CM%)

Have a screed specialist in your area give you a residual moisture report!

Wet rooms, damp rooms, saunas, carpeting and xyolith are not suitable subfloors. The subfloor must be dry, level, firmly affixed and clean. Minor unevenness can be compensated with an underlay mat or – if exceeding 3 mm/m – sanded down or leveled with a filler.

Cleaning and care

Kronotex laminate floors are not only hygienic but also very easy to look after.

- Sweep the dry floor with a soft broom or use a vacuum cleaner.
- Marks and dirt can be wiped off with a slightly damp cloth, following the grain of the plank.
- For stubborn marks, please use Kronotex cleaner.
- Please use felt pads under furniture and soft rubber castors on chairs.
- Place door mats in special areas (hall, entrance). In industrial buildings, provide footwells.
- Minor damage to the floor can easily be repaired with a repair kit.
- In case of more serious damage, please consult a specialist.

Floor heating – no problem

Kronotex laminate floors can be readily installed upon underfloor heating, serve well and even help to save on heating costs.

- Be sure to heat mineral underlays before flooring installation to eliminate any excess dampness.
- Have a heating specialist in your area give you a heating report.
- Ensure that during installation, the surface temperature of the floor is at least 15 °C (60 °F).
- For dampness insulation and as a vapor barrier, use a PE film (0.2mm) underlayment. To dampen sound, use PE foam or Kronotex matt underlay.
- At the beginning of each heating period, when you first turn on the underfloor heating, raise the temperature gradually in 5 °C (9 °F) increments per day until you reach the desired temperature. The floor's surface temperature should not exceed 26 °C (80 °F).





KRONOTEX ACCESSORIES



SKIRTING BOARD KTEX 1

MDF, for attachment system

19 x 58 x 2400 mm

PACKET 10 pcs

PALLET 56 packets

Available décors: see page 77.



SKIRTING BOARD KTEX 4

MDF, for attachment system

22 x 40 x 2400 mm

PACKET 10 pcs

PALLET 72 packets

Available décors: see page 77.



SKIRTING BOARD KTEX 6

MDF, for attachment system

19 x 80 x 2400 mm

PACKET 10 pcs

PALLET 20 packets

Available décors: see page 77.



SKIRTING BOARD KTEX P

MDF, white, profiled, paintable

18 x 80 x 2400 mm

PACKET 8 pcs

PALLET 35 packets



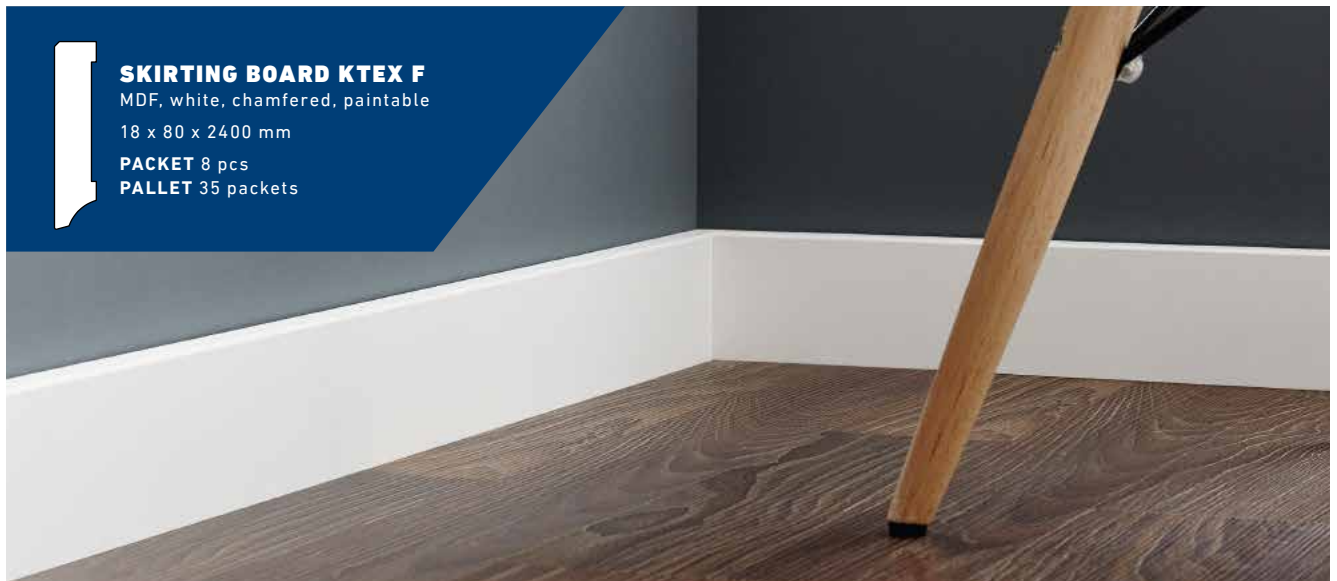

SKIRTING BOARD KTEX F

MDF, white, chamfered, paintable

18 x 80 x 2400 mm

PACKET 8 pcs

PALLET 35 packets



CORNER PIECE FOR SKIRTING BOARDS KTEX F AND KTEX P

22 x 22 x 82 mm

PACKET 2 pcs

Available in white décor

ACCESSORIES FOR SKIRTING BOARD KTEX 1

	Packet	Economy pack (packet)
1 External corner piece*	2 pcs per packet	2 pcs
2 Internal corner piece*	2 pcs per packet	6 pcs
3 End cap*	1 x left and 1 x right per packet	1 x left and 1 x right
4 Connector*	2 pcs per packet	-
	Box 10 packets	Box 5 packets

*Available in these colours: Light brown, dark brown, white, silver and stainless steel look

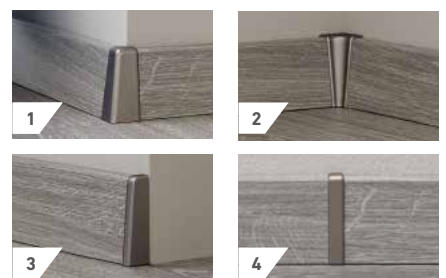

ACCESSORIES FOR SKIRTING BOARD KTEX 4

	Packet	Economy pack (packet)
1 External corner piece*	2 pcs per packet	2 pcs
2 Internal corner piece*	2 pcs per packet	6 pcs
3 End cap*	1 x left and 1 x right per packet	1 x left and 1 x right
4 Connector*	2 pcs per packet	-
	Box 10 packets	Box 5 packets

*Available in these colours: Light brown, dark brown, white, silver and stainless steel look



KRONOTEX ACCESSORIES



SKIRTING BOARD CLIPS

For quick and easy installation of skirting boards

PACKET 30 pcs



ANTISTATIC CLEANER

PACKET 6 pcs



KRONOTEX INSULATION UNDERLAYS

BASIC

Foam-based

25.000 × 1.000 × 2 mm

1 PACK 4 rolls = 100 m²

1 PALLET 40 rolls



BASIC PLUS

Foam-based with flat laminated PE foil

25.000 × 1.000 × 2 mm

1 PACK 4 rolls = 100 m²

1 PALLET 40 rolls



PREMIUM SOUND

PU-based with foil lamination

8.500 × 1.000 × 1,8 mm

1 PACK 1 roll = 8,5 m²

1 PALLET 40 rolls



SUPERIOR SOUND

PU-based with foil lamination















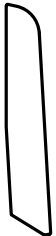

5.500 × 1.000 × 2,8 mm

1 PACK 1 roll = 5,5 m²

1 PALLET 40 rolls



OTHER KRONOTEX SKIRTINGS

 <p>Skirting board KTEX 5 MDF 15 x 70 x 2400 mm</p>	 <p>Skirting board KTEX 10 MDF 10 x 58 x 2400 mm</p>	 <p>Skirting board KTEX 11 MDF, for attachment system 21 x 70 x 2400 mm</p>
 <p>Skirting board KTEX 12 MDF, for attachment system 15*/19,5** x 50 x 2400 mm</p>	 <p>Skirting board KTEX 13 MDF, for attachment system 16 x 58 x 2600 mm</p>	 <p>Skirting board KTEX 14 MDF, for attachment system 17 x 70 x 2600 mm</p>
 <p>Skirting board KTEX 15 MDF 16 x 80 x 2600 mm</p>	 <p>Skirting board KTEX 16 MDF 15 x 78 x 2400 mm</p>	 <p>Skirting board KTEX 17 MDF 18 x 40 x 2400 mm</p>
 <p>Skirting board KTEX 18 MDF, for attachment system 13,5*/19* x 40 x 2400 mm</p>	 <p>Skirting board KTEX 19 MDF, for attachment system 18 x 90 x 2400 mm</p>	 <p>Skirting board KTEX 20 MDF 17 x 17 x 2400 mm</p>
 <p>Skirting board KTEX 21 MDF 12 x 12 x 2400 mm</p>	 <p>Skirting board KTEX 22 MDF 16 x 16 x 2400 mm</p>	 <p>Skirting board KTEX 23 MDF 6 x 25 x 2600 mm</p>
 <p>Skirting board KTEX 24 MDF 4 x 25 x 2400 mm</p>	<p>Available in all laminate flooring decors.</p> <p>Different quantities available by prior arrangement. * Covered distance from wall w/o clips ** Covered distance from wall with clips</p>	

AVAILABLE DECORS FOR SKIRTING BOARDS

Dekor no.	KTEX 1	KTEX 4	Dekor no.	KTEX 1	KTEX 4	Dekor no.	KTEX 1	KTEX 4
D 1407	•	•	D 3242	•	•	D 4720	•	
D 2304	•	•	D 3570	•	•	D 4725	•	
D 2450	•	•	D 3571	•		D 4726	•	
D 2774	•	•	D 3572	•	•	D 4727	•	
D 2800	•		D 3573	•		D 4728	•	
D 2801	•		D 3585	•	•	D 4731	•	
D 2804	•	•	D 3590	•		D 4732	White is recommended	
D 2805	•	•	D 3591	•		D 4738	White is recommended	
D 2869	•		D 3592	•		D 4739	White is recommended	
D 2870	•		D 3597	•		D 4751	•	•
D 2873	•	•	D 3660	•	•	D 4752	•	
D 2905	•	•	D 3661	•	•	D 4753	•	•
D 2929	•	•	D 3662	•	•	D 4754	•	•
D 2949	•	•	D 3663	•	•	D 4755	•	•
D 2955	•	•	D 3664	•	•	D 4757	•	•
D 2957	•	•	D 3665	•	•	D 4760	•	•
D 2963	•		D 3667	•	•	D 4763	•	•
D 2967	•		D 3668	•	•	D 4764	•	•
D 2986	•	•	D 3669	•		D 4765	•	•
D 2987	•	•	D 3670	•		D 4766	•	•
D 2994	•		D 3672	•	•	D 4767	•	•
D 2999	•		D 3673	•	•	D 4771	•	•
D 3000	•		D 3676	•	•	D 4773	•	•
D 3001	•		D 3901	•	•	D 4779	•	
D 3004	•	•	D 4127	•	•	D 4780	•	•
D 3007	•	•	D 4152	•		D 4781	•	•
D 3044	•	•	D 4155	•	•	D 4782	•	•
D 3066	•	•	D 4163	•	•	D 4783	•	•
D 3070	•	•	D 4164	•	•	D 4784	•	•
D 3073	•		D 4166	•	•	D 4785	•	•
D 3074	•		D 4169	•	•	D 4786	•	•
D 3075	•		D 4170	•	•	D 4787	•	•
D 3076	•		D 4171	•	•	D 4790	•	•
D 3077	•		D 4700	•	•	D 4791	•	
D 3079	•		D 4702	•	•	D 4792	•	
D 3081	•		D 4703	•	•	D 4793	•	
D 3178	•		D 4704	•	•	D 4794	•	
D 3179	•		D 4705	•		D 4795	•	
D 3180	•		D 4706	White is recommended		D 4796	•	
D 3181	•		D 4707	•		D 4797	•	
D 3223	•	•	D 4708	White is recommended		D 4798	•	
D 3224	•	•	D 4710	•		D 4953	•	•
D 3239	•		D 4715	•				
D 3241	•	•	D 4716	•				

Dekor no.	KTEX 6	Dekor no.	KTEX 6	Dekor no.	KTEX 6
Q 001	Black or white is recommended	D 2919	•	D 3688	•
Q 004	Black or white is recommended	D 2920	•	D 4178	•
Q 010	Black or white is recommended	D 2921	•	D 4179	•
D 2909	•	D 2935	•	D 4181	•
D 2911	•	D 3527	•	D 4187	•
D 2913	•	D 3528	•	D 4188	•
D 2916	•	D 3547	•	D 4189	•
D 2918	•	D 3550	Black or white is recommended	D 8434	•
		D 3685	•	U 190 HG	•
		D 3686	•	U 190 Matt Finish	•

ONLINE FLOOR STUDIO

Experience the effect of differing woods, ornamentation, wall and furniture colours in an accurate representation of any room. The online floor studio is the ultimate tool for both end user and salesman.

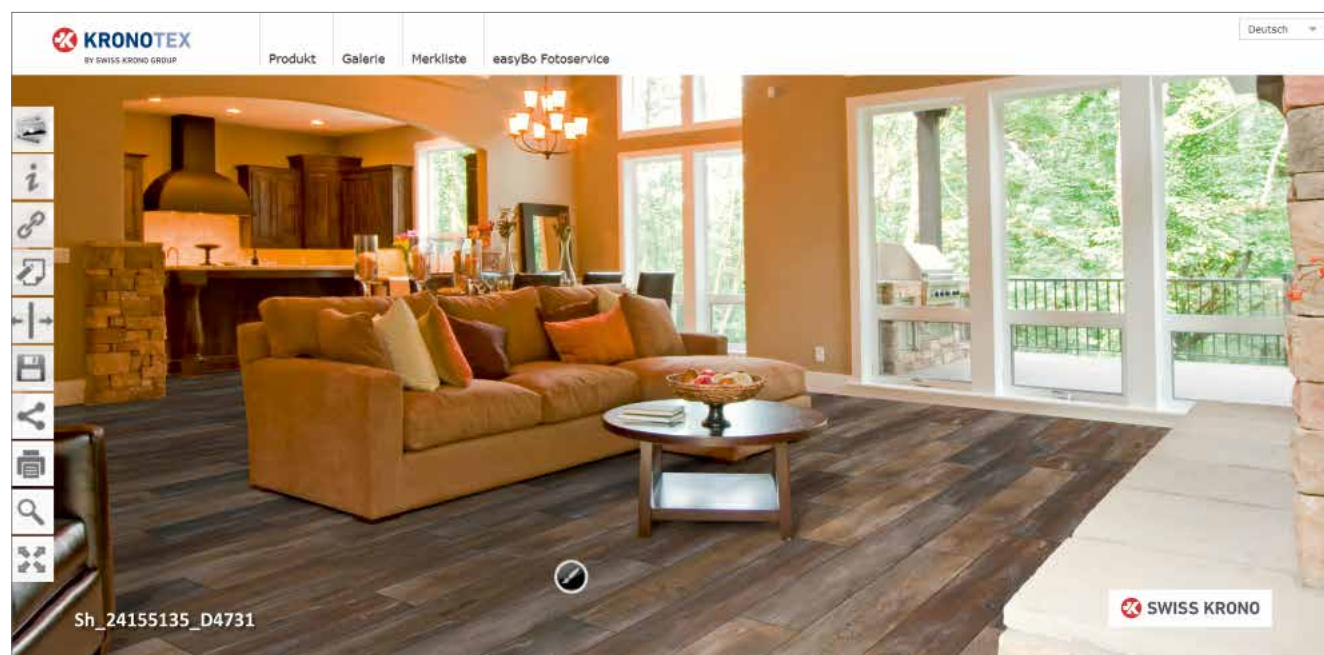

Colour selector

With one mouse click you can select the appropriate shade and tone from our whole collection.

Additional selection criteria

These offer the perfect opportunity to narrow down your search for the perfect laminate. You can select from various qualities, including the type of element, the decoration number or the strength.

Surface view

Allows you to view elements from both head-on and in perspective.

Notes

Gives you the opportunity to get extra information about any of our products simply and conveniently.

The link function

With the link function, you can put your ideas before customers, suppliers, users and planners.



QUALITY ON PRINCIPLE

Not only do SWISS KRONO TEX floors meet the prescribed norms, they consistently exceed them! This is possible because SWISS KRONO TEX adopts a fully-integrated approach to production (from the tree through to the finished panel), and has numerous control and measuring devices at its disposal. For this reason, Kronotex can offer guarantees which go far and beyond warranties under law. You will be hard pressed to find any other producer who can do likewise.

SWISS KRONO TEX GmbH & Co. KG (in the following: Kronotex) provides buyers in addition to the unencumbered guarantee under law, an additional guarantee covering the abrasion resistance of the floor's surface. It extends from the date of purchase and covers the products as follows:

Conditions of guarantee

Kronotex laminate panels must be checked before and during installation for any defects. No liability is accepted for laminate flooring installed despite visible defects. Kronotex laminate floors must be installed properly according to the instructions, in a dry room, and in accordance with the respective use class. No liability is accepted for Kronotex laminate

floors installed in damp rooms. Abrasion areas on Kronotex laminate floors must be clearly visible and at least 1 cm² in size. And in particular the design layer must be completely abraded. No liability is accepted for abrasion on the edges of the elements or for unusual or improper use, and in particular for damage caused by mechanical stress. Validity of guarantee is dependent on regular cleaning and maintenance of Kronotex floors as described in the care instructions. Claims under guarantee are valid only if submitted within 30 days of ascertaining damage and accompanied by the original receipt from the retailer. In investigating a guarantee claim, Kronotex retains the right to examine the floor in question on site.

Our guarantee

In cases falling under guarantee, Kronotex will deliver a replacement for the damaged element. If the flooring in question is no longer available, then the buyer can choose a replacement of equal value from the current Kronotex product line.

Since an annual 10% depreciation in the value of Kronotex laminates can be assumed, delivery of a compensation product is dependent on payment of the appropriate difference by the buyer.

No liability is accepted for further damages, especially consequential damages such as those incurred during installation or removal, or transport costs for damaged Kronotex laminate floors.



EN 14041

www.blauer-engel.de/uz176

The mark of responsible forestry



Made in Germany

Manufacture and product control are in accordance with DIN EN 13329. The right to technical modifications is reserved. The illustrations may differ from the actual products. As of 02-2018.

Art.-Nr.: T00002

Layout: Vogelsänger

Pictures: SWISS KRONO TEX, Vogelsänger,
Shutterstock, Döring & Waesch
EN 003-0518-DW-WEI



SWISS KRONO TEX GmbH & Co. KG
Wittstocker Chaussee 1
D-16909 Heiligengrabe / Germany
sales.floor@swisskrono.de
www.swisskrono.de